

CROSS-R/RV TECHNICAL DATA

TAPPING CENTRES AND BRACKETS

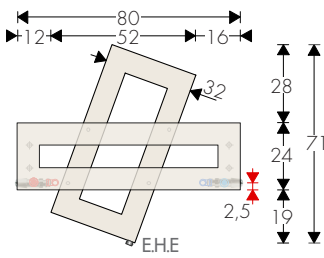

CROSS-R 70-80

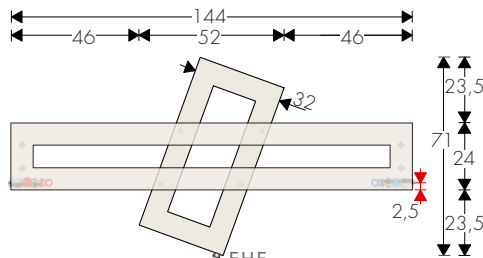

CROSS-R 70-144

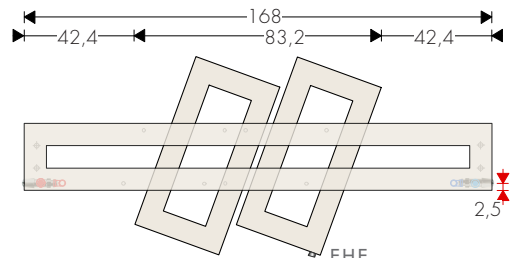

CROSS-R2 70-168

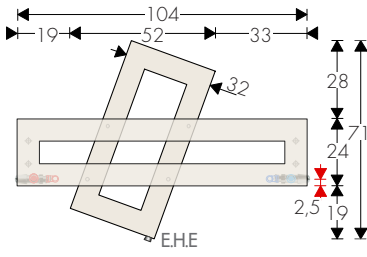

CROSS-R 70-104

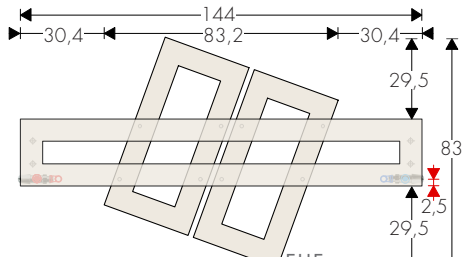

CROSS-R2 83-144

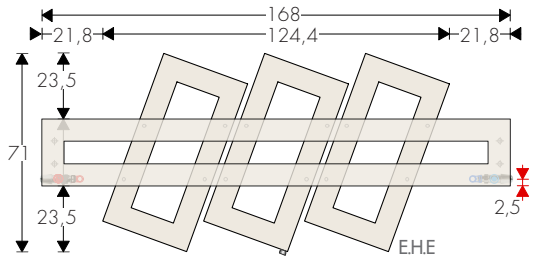

CROSS-R3 70-168

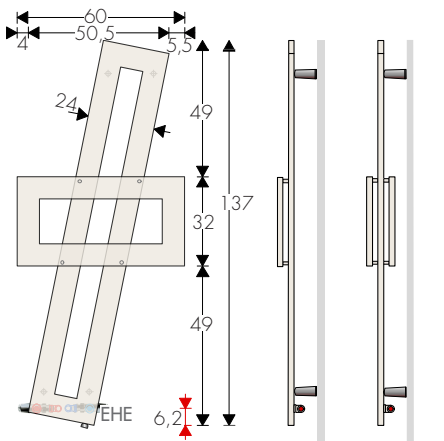

CROSS-R 137-60

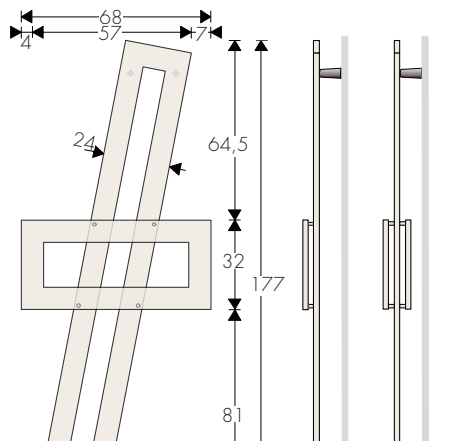

CROSS-RD 137-60

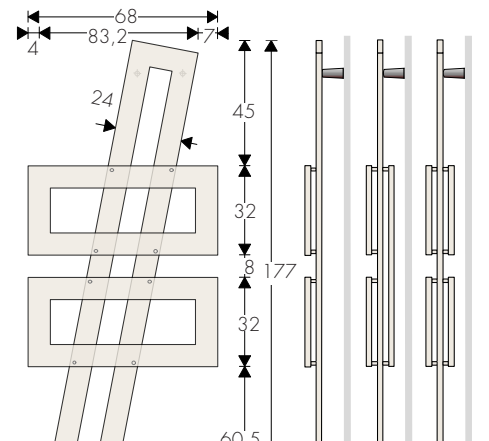

CROSS-R2 177-68

E.H.E.: Sleeve for Electric Heating Element (on request)

CROSS-R 177-68

CROSS-RD 177-68

CROSS-2R 177-68

CROSS-2R 177-68
CROSS-3R 177-68
CROSS-4R 177-68

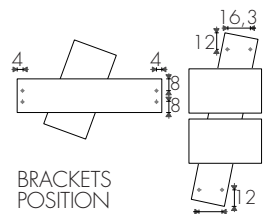

BRACKETS POSITION

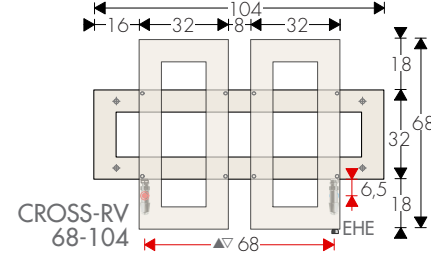

CROSS-RV 68-104

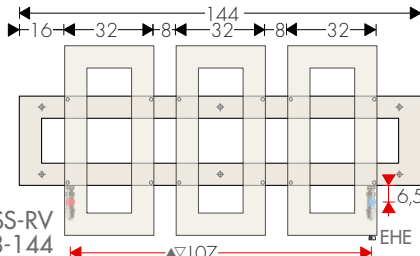

CROSS-RV 68-144

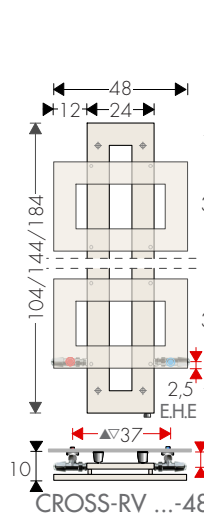

CROSS-RV ...-48

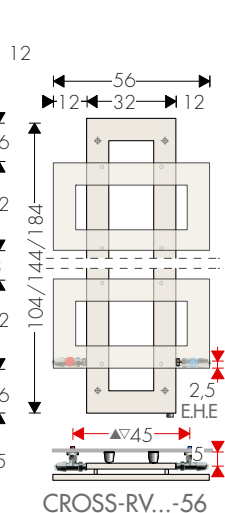

CROSS-RV ...-56

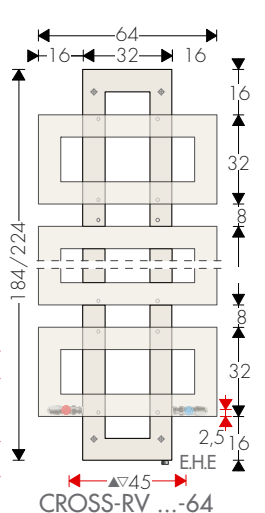

CROSS-RV ...-64